

SECTION A-A

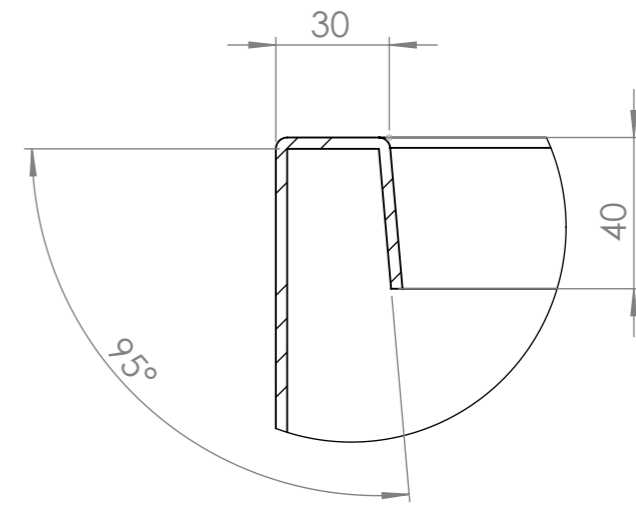

DETAIL B

SCALE 1 : 2

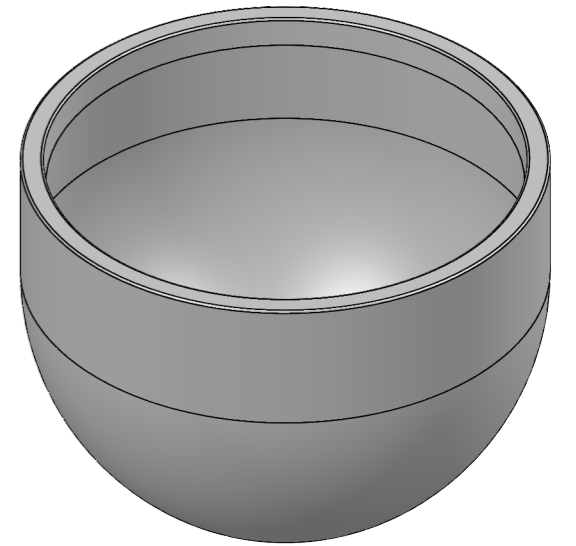

DRAWN	Pleuni Bongers	DATE	29-8-2025
REVISION	Dorus Bannenber	DATE	26-2-2026



TITLE:	PVR2	
--------	------	--

**ADEZZ**  
DESIGN TO GROW

Liessentstraat 4, 5405 AG Uden (NL).  
t 0031 (0)413 - 27 41 68.  
e info@adezz.com, i www.adezz.com

Drawing:	PVR2	A3
----------	------	----

Color:	-	Mass (kg):		SCALE:1:10	SHEET 1 OF 1
--------	---	------------	--	------------	--------------